



Pump Discharges (Standard)

PDS-EDS-1.25, PDS-EDS-1.5, PDS-EDS-2.0

PDS-EDS-1.25-D, PDS-EDS-1.5-D, PDS-EDS-2.0-D

Features

- Ideal for effluent, sewage or high head turbine pump applications
- Pre-assembled for quick installation
- Newly designed for easier STEP system maintenance

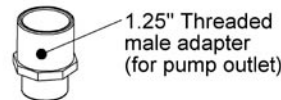
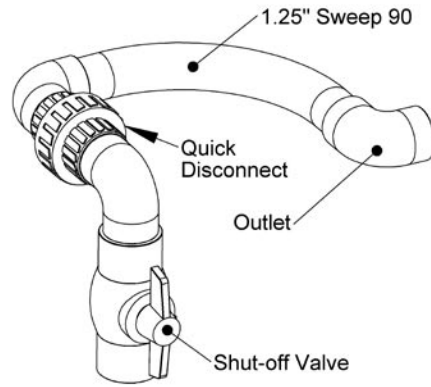

1.25" Single discharge

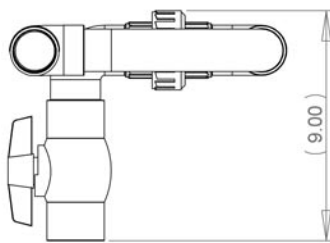
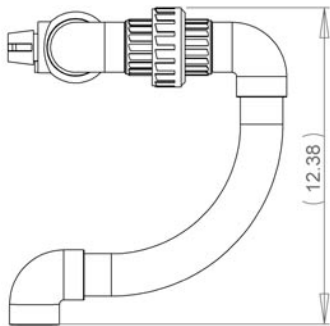

2" Dual discharge

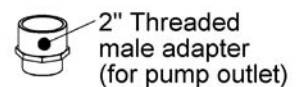
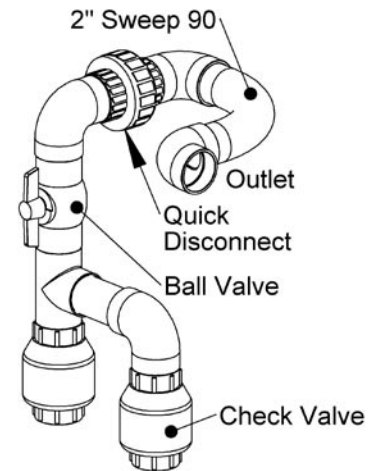
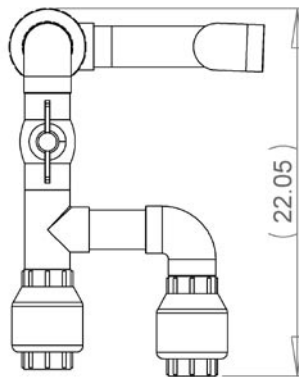
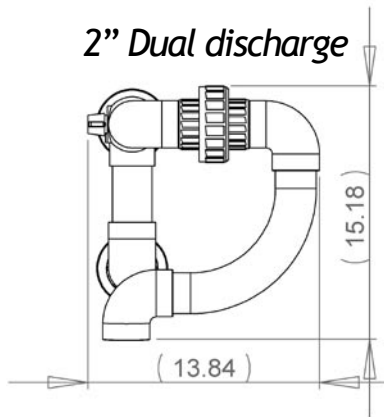

Materials

All pipe and fittings

- SCH 40 PVC

Ball valve

- PVC plastic
- Double block, full port design
- Slip/slip hubs

Check valve

- PVC plastic swing type (duplex model only)

Warranty for Defects in Material and Workmanship

- 1 Year

AutoCad dwg files at www.quanics.net